

规格书

SPECIFICATION FOR APPROVAL

公司名称 _____
Company Name _____

产品名称 _____
Product Name _____

规格型号 _____
Part NO _____

日期 _____
Date _____

客户确认(For customer confirm)

承认(Confirm)	审核(Auditing)	批准(Approve)

制表(Make)	审核(Auditing)	批准(Approve)



Feature

- * Tri-proof LED fixture for IP65 Waterproof,Dust,Corrosion and pressure-proof
- * Patent and functional design with imaginative appearance
- * High Stability isolated driver
- * Excellent heat dissipation depend on whole aluminum house
- * widely use for Humid ambient lighting application
- * Maximum efficacy and minimum glare
- * High-tech optical design
- * No UV,No Lead,No Mercury CE RoHs UL

Application

Car park,Swimming pool,warehouse,Gas station,Kitchen etc place with dust,humit

Product Image



Parameter

Mole	TP30W-U60	TP48W-U120	TP60W-U150
Input Power(W)	30W	48W	60W
Input Volt(V)	100-240V	100-240V	100-240V
Frequency(HZ)	50/60 HZ	50/60 HZ	50/60 HZ
Power factor(PF)	>0.9	>0.9	>0.95
Output Volt(V)	37V	37 V	37V
Output Current(mA)	760mA	1250mA	1540Ma
Output Power(W)	28.4W	46.5W	57.3 W
LED Type	2835	2835	2835
LED Qty(PCS)	168	288	336
Beam angle	180°	180°	180°
Lifespan	50000	50000	50000
IP Rank	IP65	IP65	IP65
Usage Tempt	-20 ~ 50°C	-20 ~ 50°C	-20 ~ 50°C
Storage Tempt	-25 ~ 60°C	-25 ~ 60°C	-25 ~ 60°C
Dimension	600 X90X75mm	1200 X90X75mm	1500 X90X75mm

Optical Parameter

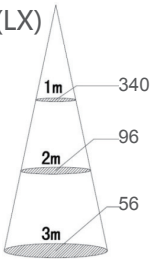
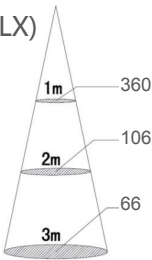
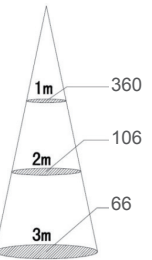
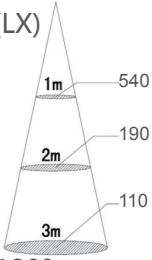
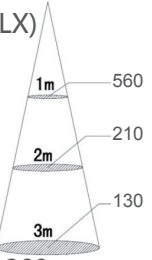
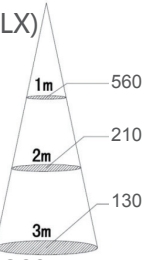
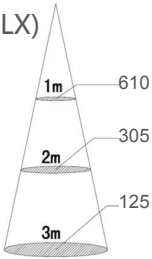
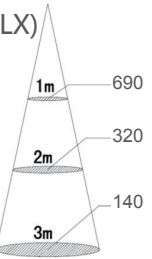
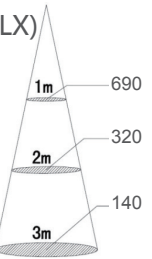
TP30W-U60	warm white(K) : 2800-3500K	Nature white(K)4000-4500K	Pure white(K):5500-6500K
	Lumen (Lm) : 2800±5%	Lumen (Lm) : 2950±5%	Lumen (Lm) : 3000±5%
	(CRI) : ≥80	(CRI) : ≥80	(CRI) : >80
	Luminous Efficiency : 95±5%	Luminous Efficiency:100±5%	Luminous Efficiency:100±5%
	Illuminance Diagram	Illuminance Diagram	Illuminance Diagram
	Average Flux(LX)  Beam angle120°	Average Flux(LX)  Beam angle120°	Average Flux  Beam angle120°
TP48W-U120	warm white(K) : 2800-3500K	Nature white(K)4000-4500K	Pure white(K):5500-6500K
	Lumen (Lm) : 4600±5%	Lumen (Lm) : 4800±5%	Lumen (Lm) : 4800±5%
	(CRI) : >80	(CRI) : >80	(CRI) : >80
	Luminous Efficiency : 95±5%	Luminous Efficiency : 100±5%	Luminous Efficiency:100±5%
	Illuminance Diagram	Illuminance Diagram	Illuminance Diagram
	Average Flux(LX)  Beam angle120°	Average Flux(LX)  Beam angle120°	Average Flux(LX)  Beam angle120°
TP60-U150	warm white(K) : 2800-3500K	Nature white(K)4000-4500K	Pure white(K):5500-6500K
	Lumen (Lm) : 5700±5%	Lumen (Lm) : 6000±5%	Lumen (Lm) : 6000±5%
	(CRI) : >80	(CRI) : >80	(CRI) : >80
	Luminous Efficiency : 95±5%	Luminous Efficiency : 100±5%	Luminous Efficiency:100±5%
	Illuminance Diagram	Illuminance Diagram	Illuminance Diagram
	Average Flux(LX)  Beam angle120°	Average Flux(LX)  Beam angle120°	Average Flux(LX)  Beam angle120°

Dimension

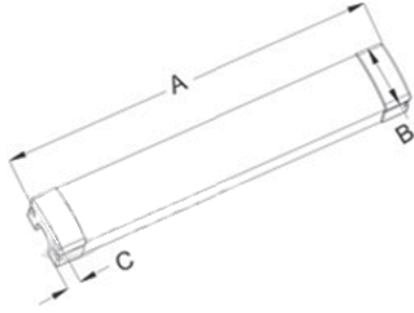

Item	TP30W-U60	TP48W-U120	TP60-U150
Size mm	600 X90X75mm	1200 X90X75mm	1500 X90X75mm
P(W)	30	48	60

Package information

Package

Item	Power	Inner size	N.W	CTN Size	G.W/CTN	Qty/CTN	Qty/layer
TP30W-U60	30W	640*100*80mm	128g	660*250*220	10Kg	6PCS	3PCS/1layer
TP48W-U120	48W	1240*100*80mm	260g	1260*250*220	17Kg	6PCS	3PCS/1layer
TP60-U150	60W	1540*100*80mm	326g	1560*250*220	21Kg	6PCS	3PCS/1layer

Package Image



Installation Guide

一、Ceiling Mounted

- 1、 Please drill hole on the ceiling by electric drill, and the holes size must be as same as screw in the same line
- 2、 Please fix the clip by the screw (Image 2)
- 3、 Please push the back of the lamp into the clips (Image 3)
- 4、 Installation is done well (Image 4)

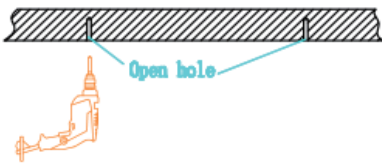

Image 1

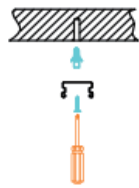

Image 2

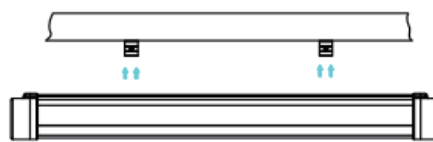

Image 3



Image 4

二、Suspending

- 1、 Please drill hole on the ceiling by electric drill, and the holes size must be as same as screw in the same line (image 1)
- 2、 Please fix one end of rope on the ceiling, and another end is with the clips (Image 2)
- 3、 Please push the back of the lamp into the clips (Image 3)
- 4、 The installation is done well. (Image 4)

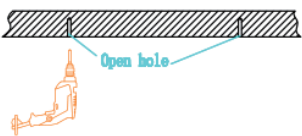

Image 1

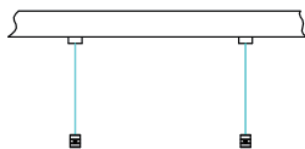

Image 2

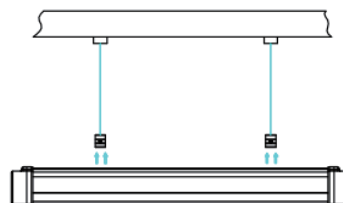

Image 3



Image 4

Installation Attentions :

- 1、 all the installation must be operated by the electrician .
- 2、 please contact the seller if there is the damage on the products before opening the package
- 3、 LED tube light is only used for indoor since it is no waterproof.

Usage Attention

- 1、 this product is used for indoor since it is nonwaterproof , don't use it for outdoor, humid, high temperature places.
- 2、 this product is not dimmable, please don't connect external dimmer in series
- 3、 please don't store it in humid environment for a long time.
- 4、 Please confirm the input way if LED tube is as same as fixture before installation, or it burn LED tube.
- 5、 please don't open it or maintain it if it is fault without our approval in order to avoid accident..